

**GENERAL FRAME INFORMATION TABLE OF CONTENTS**

General Frame Information.....	2
Primary & Endwall Framing Column Layout Information .....	3
TCG – Tapered Beam, Clear Span, Gable.....	4
TCG Framing Features .....	4
RCG – Rigid Frame, Clear Span, Gable.....	5
RCG Framing Features .....	5
RMG-X – Rigid Frame, Modular, Gable.....	6
RMG-X Framing Features .....	6
RCS – Rigid Frame, Clear Span, Single Slope .....	7
RCS Framing Features .....	7
RMS-X – Rigid Frame, Modular, Single Slope.....	8
RMS-X Framing Features .....	8
LCS – Lean-To .....	9
LCS Framing Features .....	9
TrussFrame .....	10
TrussFrame Features .....	10

## GENERAL FRAME INFORMATION

### NUCOR BUILDING SYSTEMS PRIMARY FRAMES

The frames that follow are typical configurations. These frames represent the most commonly specified Nucor Building Systems framing systems. Consult with your the engineering team for more information and specific assistance.

Additional information about available Primary Framing Systems is available at the Nucor Building systems website at the below link.

[Nucor Building Systems Primary Framing Systems](#)

The following pages outline Nucor standard primary framing systems.

**PRIMARY & ENDWALL FRAMING COLUMN LAYOUT INFORMATION**

This page is intended to show basic terminology and standard column locations to assist you in communicating specific needs for quotes and orders. Knowing this information can save both time and cost by allowing us to serve you in the most effective way.

LEW = LEFT ENDWALL  
 REW = RIGHT ENDWALL  
 FSW = FRONT SIDEWALL  
 BSW = BACK SIDEWALL

\*Standard post & beam corner column orientation is shown. However, based on building requirements, this column will sometimes be rotated 90°.

A = Girt offset as defined on the order documents.

**NOTE:** "STEEL LINE = THE OUTSIDE FACE OF THE GIRTS.

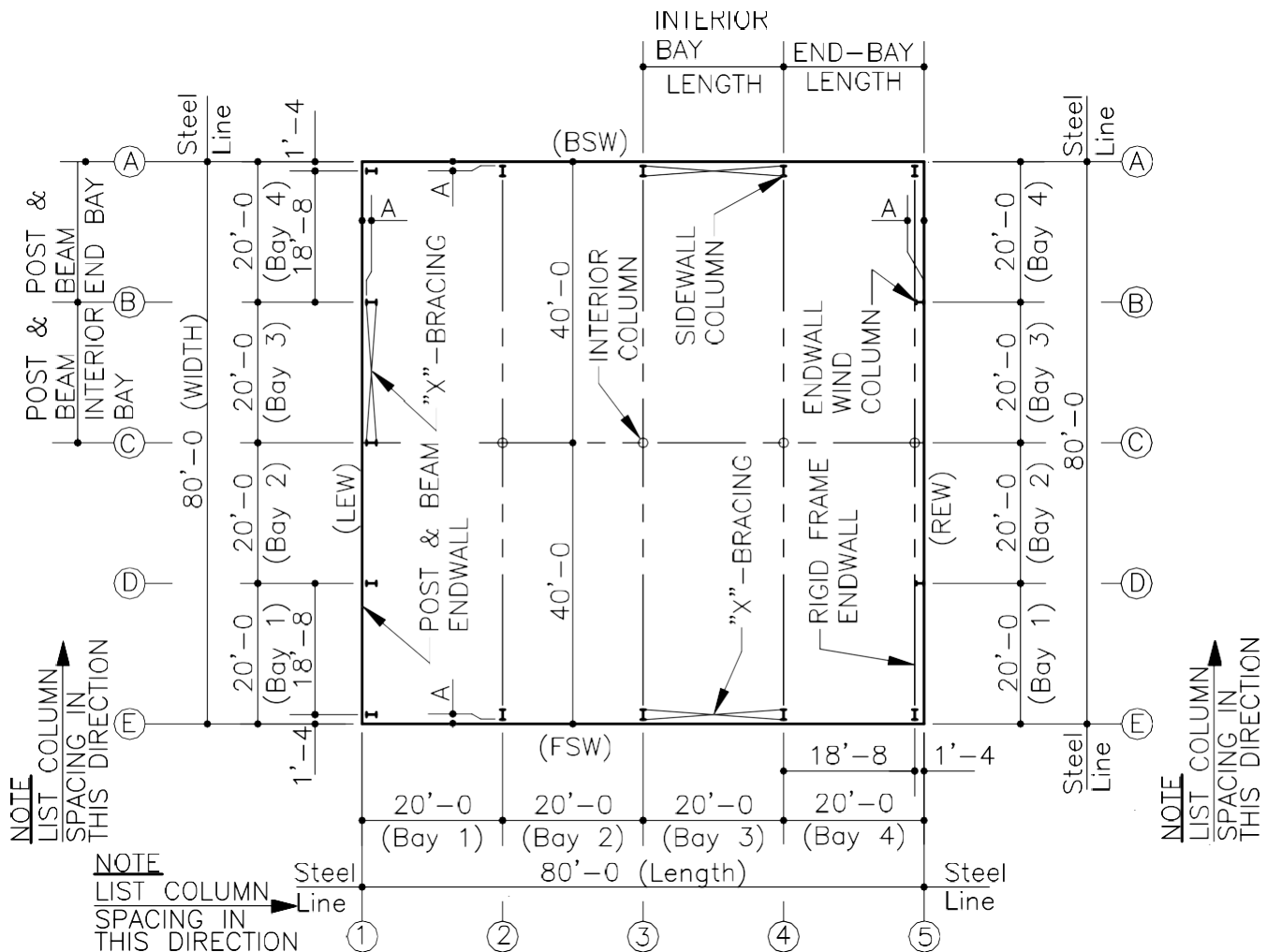

## TCG – TAPERED BEAM, CLEAR SPAN, GABLE

### TCG FRAMING FEATURES

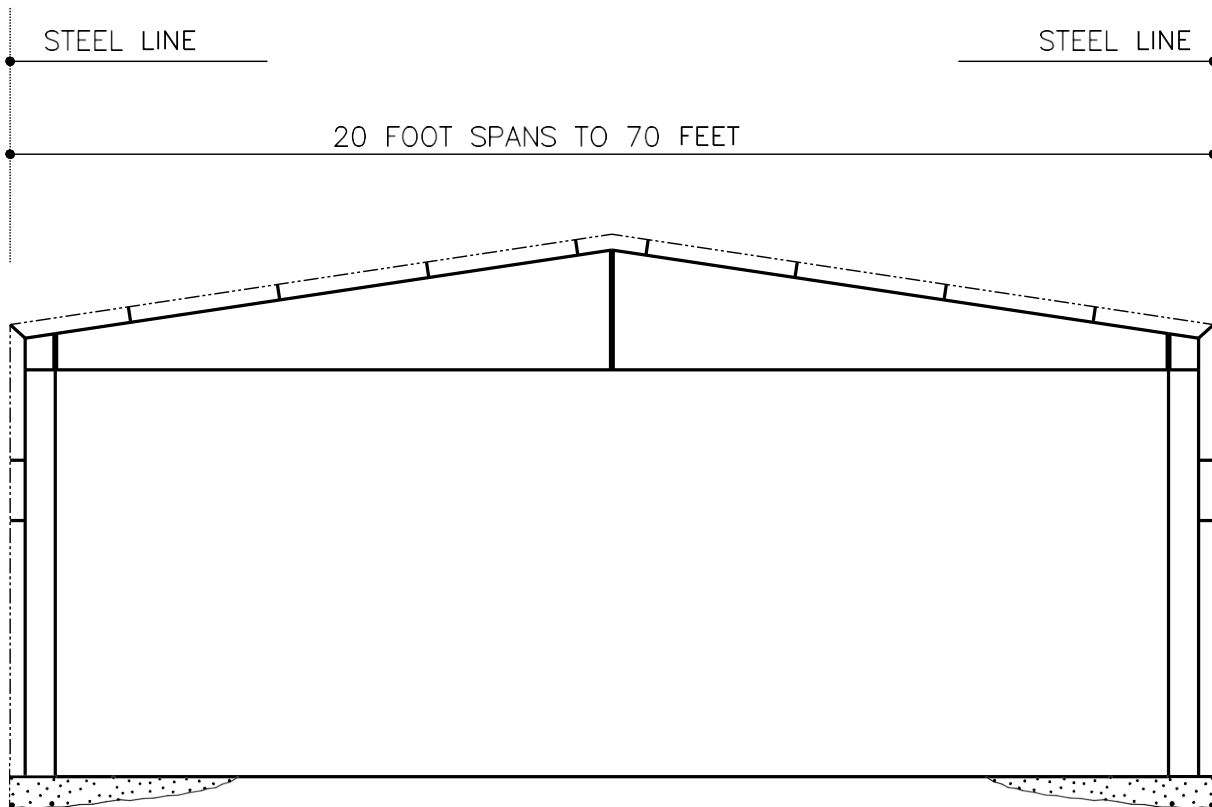

### **TCG FRAMING FEATURES**

1. Tapered Beam (TCG) frames are an excellent solution for small buildings under 70 feet in width.
2. Straight columns provide maximum floor space and allow interior finishes to be easily installed.
3. TCG frames, with flat bottom rafter and straight columns, permit the easy installation of monorail and under-hung crane ways.
4. Single slope TCG frames are an excellent framing system for use as strip shopping centers.

**RCG – RIGID FRAME, CLEAR SPAN, GABLE**

**RCG FRAMING FEATURES**

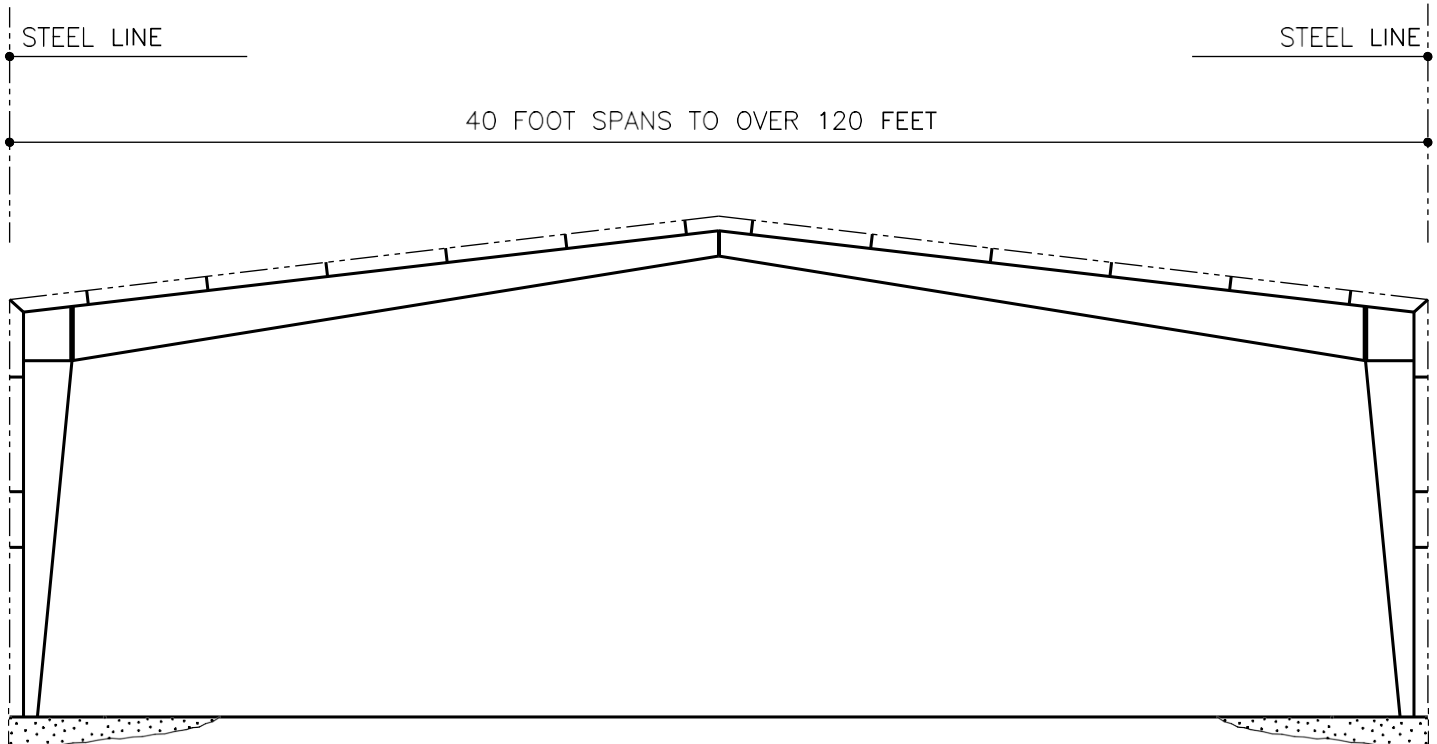

**RCG FRAMING FEATURES**

1. RCG Rigid Frames provide for the widest possible spans without interior columns.
2. RCG Rigid Frames are economical due to the efficient use of tapered members and high strength steel.
3. RCG Rigid Frames maximize the clearance available in the center of a building.
4. “By-pass” is the standard girt condition at sidewalls.

**RMG-X – RIGID FRAME, MODULAR, GABLE**

**RMG-X FRAMING FEATURES**

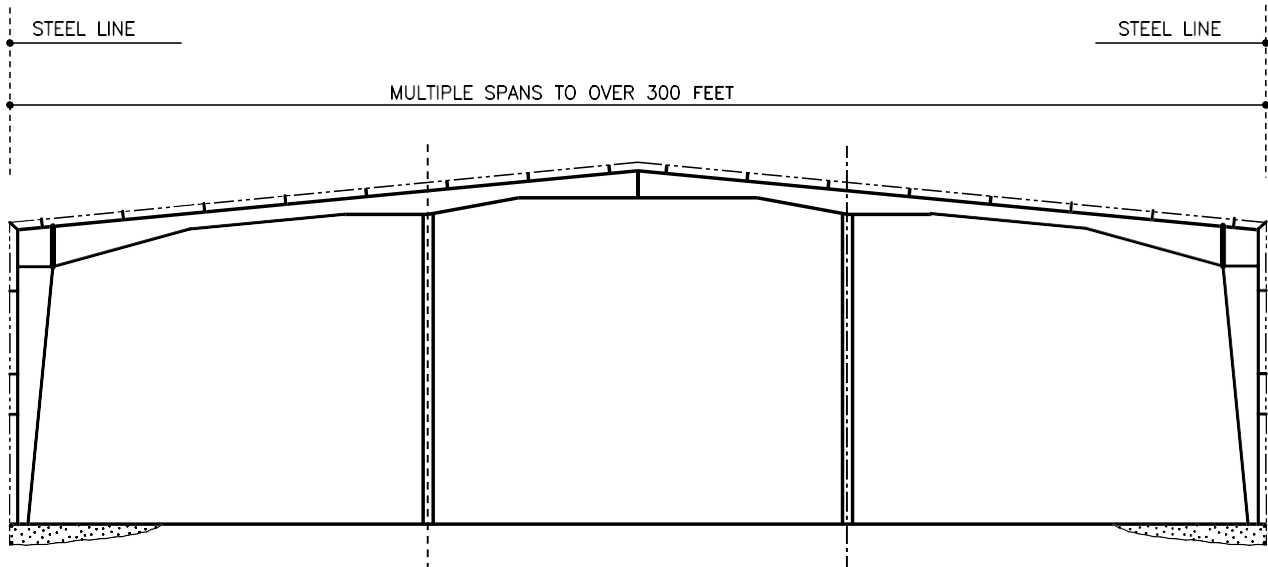

**RMG FRAMING FEATURES**

1. Rigid frames with interior columns (RMG-X [X = number of interior columns]) are ideal for wide buildings when some interior columns are acceptable.
2. RMG Rigid Frames may be used with Z-purlins for maximum economy on bay spacing of up to 40 feet or with bar joist roof purlins to achieve large, column-free areas of over 3000 square feet (60' span with 50' bays).
3. Standard interior columns are pipes, which provide maximum strength while using minimum floor space. Interior column bases may be recessed below the finished floor for a clean appearance.

**RCS – RIGID FRAME, CLEAR SPAN, SINGLE SLOPE**

**RCS FRAMING FEATURES**

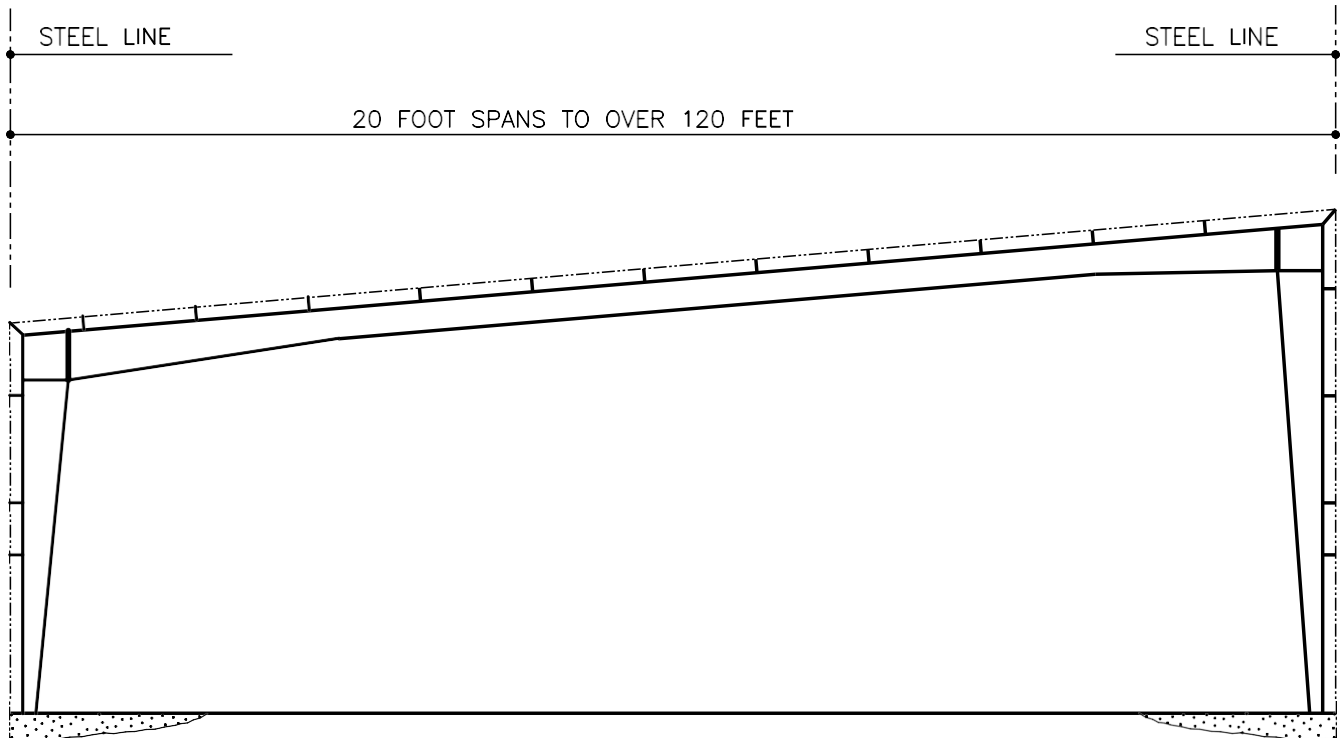

**RCS FRAMING FEATURES**

1. RCS Single Slope buildings are ideal for structures that have drainage restrictions such as a strip shopping center, or architectural requirements prohibiting a gable appearance (requires the use of endwall parapets). Also good for future sidewall expansion.
2. RCS Single Slope frames are economical due to the efficient use of tapered members and high strength steel.
3. RCS Single Slope frames maximize the clearance available in a building.

**RMS-X – RIGID FRAME, MODULAR, SINGLE SLOPE**

**RMS-X FRAMING FEATURES**

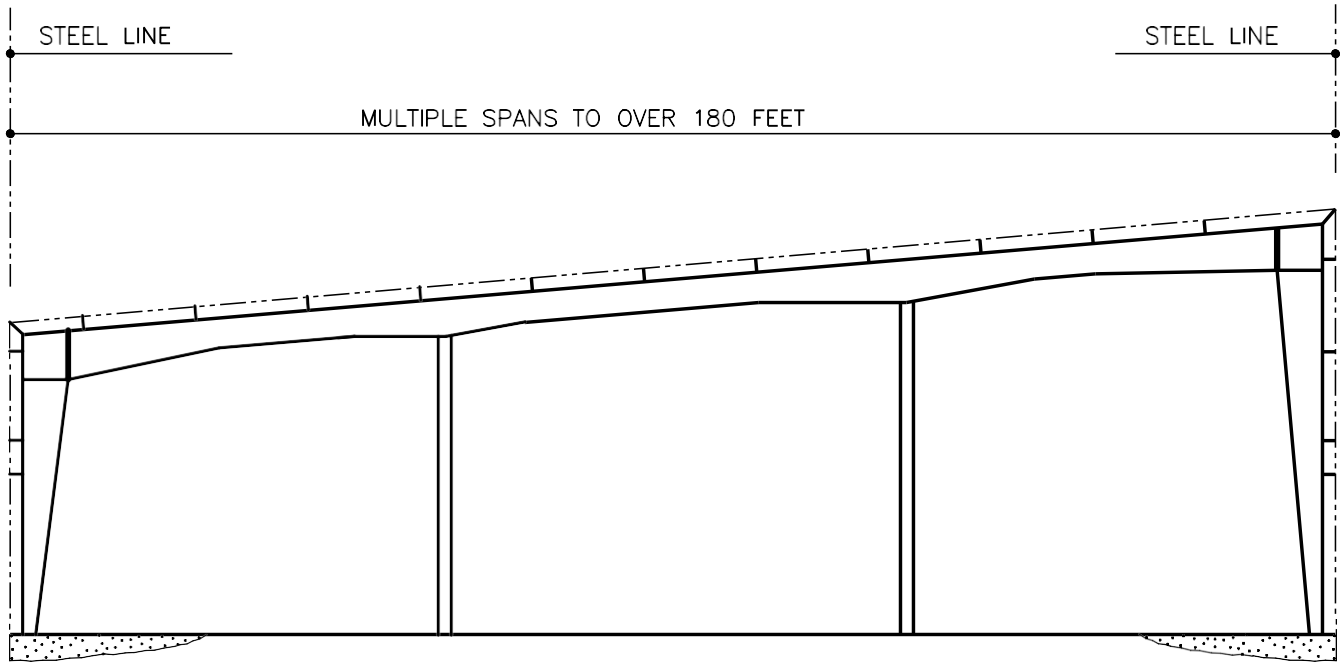

**RMS FRAMING FEATURES**

1. Single Slope frames with interior columns (RMS-X [X = number of interior columns]) are ideal for wide structures that have drainage restrictions such as a strip shopping center, or architectural requirements prohibiting a gable appearance (requires the use of endwall parapets).
2. RMS Single Slope frames may be used with Z-purlins for maximum economy with bay spacing of up to 40 feet or with bar joists to achieve large, column-free areas of over 3000 square feet (60' span with 50' bays).
3. Standard interior columns are pipes, which provide maximum strength while using minimum floor space. Interior column bases may be recessed below the finished floor for a clean appearance.



## LCS – LEAN-TO

### LCS FRAMING FEATURES

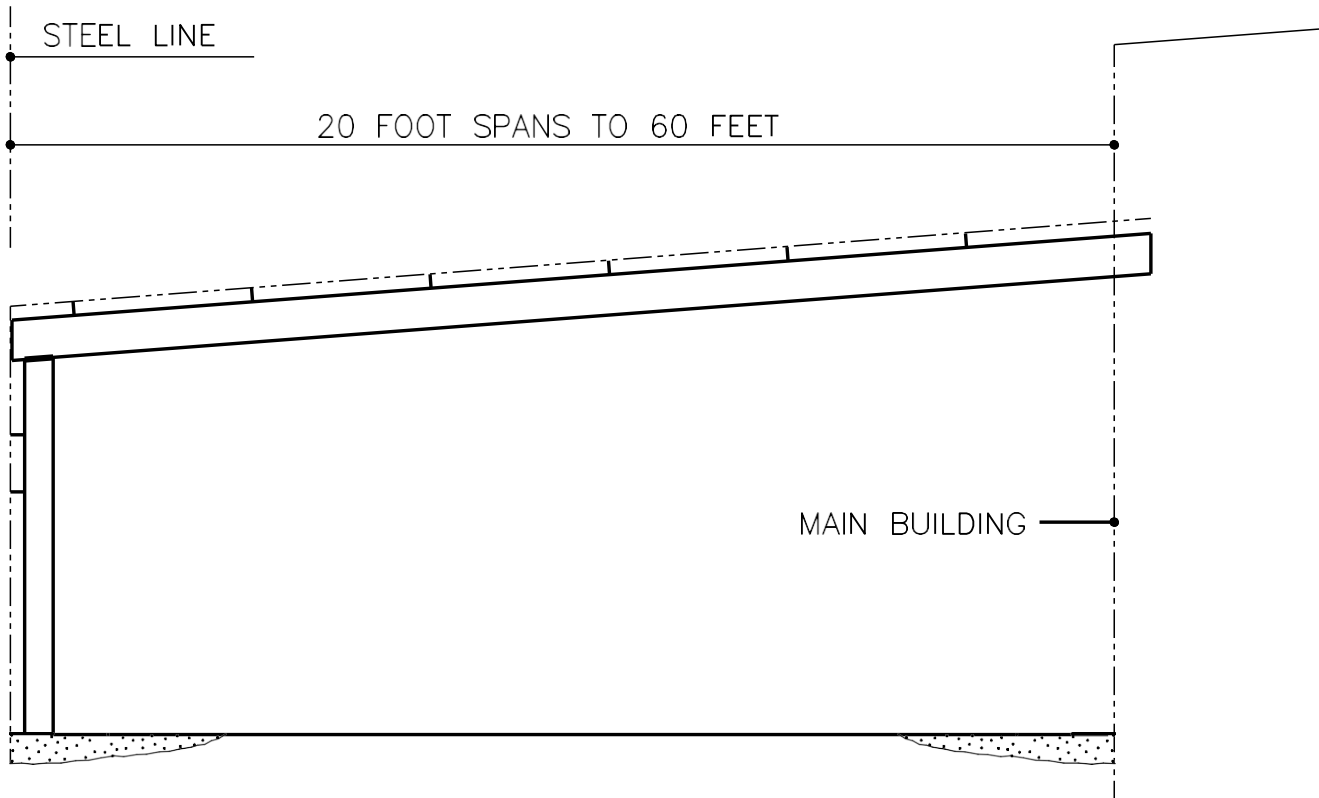

### **LCS FRAMING FEATURES**

1. Lean-to (LCS) frames are ideal for use as office structures attached to larger or taller buildings.
2. LCS frames are well suited for use with architectural accessories such as canopies and fascias.
3. LCS framing is an economical solution for the expansion of existing buildings. (Note: A minimum 1'-3" roof step is recommended at this condition.)
4. Straight columns provide maximum floor space and allow interior finish to be easily installed.
5. LCS frame design minimizes horizontal thrusts so smaller and less expensive foundations may be used.
6. If used to expand from an existing building, verification that existing building will handle new loading must be made by Project Engineer of Record.

**TRUSSFRAME**

**TRUSSFRAME FEATURES**

TrussFrame utilizes open web rafters and straight or tapered solid web columns to be able to obtain up to 250'-0" + Clearspan frames depending on design criteria. Inside clearances depend on building width, roof slope, and loading criteria. Standard rafter depths range up to 12'. Please note that truss rafters greater than 60" deep will require additional chord bracing. Contact your divisional engineering team for details.

Interior columns can be used to accommodate larger buildings. Interior modules can span to +/- 200' depending upon design criteria.

Available in Gable and Single Slope.

Go to the [nucorbuildingsystems.com](http://nucorbuildingsystems.com) site for brochures and other literature.

